







254 BF

3,6 t

CE



-  Ponte con basamento portante e trasmissione a cardano
-  Lift with self supporting baseframe and shaft transmission
-  Hebebühne mit tragendem Grundrahmen und Kardanantrieb
-  Pont à base porteuse et transmission à cardan
-  Elevador con base portante y transmisión por cardán



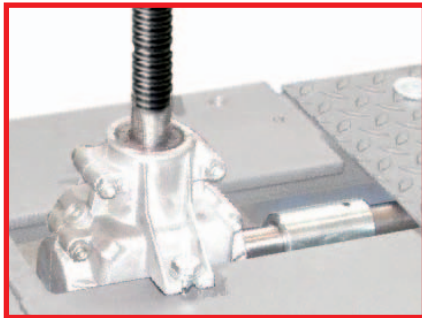

Trasmissione fra le colonne tramite barra rotante e scatole angolari con ingranaggi conici a bagno d'olio che non richiedono alcuna manutenzione

Shaft transmission between posts through oil-filled conic gear boxes requiring no maintenance

Die Übertragung zwischen den Säulen erfolgt mittels einer Kardanwelle und Winkelgetrieben mit wartungsfreien, im Oel laufenden Kegelradpaaren

Transmission entre colonnes par cardan et boîtiers à couples d'engrenages coniques à bain d'huile qui ne nécessitent pas d'entretien

Transmisión entre las columnas por cardan y cajas de engranajes selladas en baño de aceite que no requieren mantenimiento alguno

Vite rullata in acciaio ad alta resistenza per garantire la massima durata nel tempo

Steel high resistance rolled screw to provide long life

Kaltgewaltzete Spindel aus gehärtetem Stahl für eine lange Lebensdauer

Vis en acier, roulée, à haute résistance, pour garantir la durée dans le temps

Husillo de acero de alta resistencia, rosca fabricada en frío con rodillos para garantizar la máxima duración en el tiempo

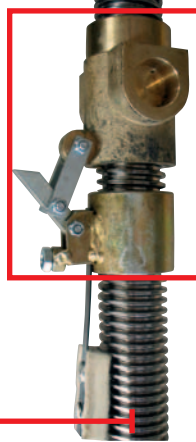

Chiocciola portante in bronzo ad elevata resistenza all'usura a garanzia di sicurezza totale

Bronze main nut with high resistance to wear for greater safety

Verschleissfeste Tragmutter aus Bronze für eine totale Sicherheit

Ecrou porteur en bronze à haute résistance à l'usure pour garantir une sécurité totale

Tuerca principal en bronce de alta resistencia al desgaste para garantizar la seguridad total



Installazione possibile anche su pavimenti che non garantiscono un ancoraggio al suolo sicuro • Colonna composta da 5 tubolari in acciaio saldati con robot • Sollevatore dotato di 2 motori. Versioni con larghezza maggiore fra le colonne (2.855 mm) • Equipaggiato con 4 bracci lunghi a tre stadi: ideali per il sollevamento di furgoni e furgonati a passo lungo, consentono allo stesso tempo caricabilità ottimale anche per le autovetture • Bracci super-ribassati, con profilo parallelo al pavimento per tutta la lunghezza del braccio: tamponi a sfilo con altezza minima di soli 90 mm. Raccomandato per veicoli sportivi o ribassati • Lubrificazione permanente e automatica della vite • Speciale motore ad alto rendimento per garantire potenza e durata nel tempo, dotato di sonda termica di protezione • Funzionamento: elettromeccanico



Possibility to install on surface floors with low anchorage strength • Two motors with a bigger width between posts (2.855 mm) • Equipped with three stage arms: perfect for lifting vans and vans with long wheelbase, at the same time they allow perfect lifting of cars • SUPER low arms, parallel to floor: thread pads with a min height of only 90mm. Recommended for sport cars and low vehicles • Automatic and permanent lubrication of the screw • Specially manufactured motors fitted with overheating protection switch • Operation: electro-mechanical



Montage auch auf Böden, die keine gute Fixierung ermöglichen. Kurze Arme zweifach ausziehbar zum Heben von Geländewagen und breiten Fahrzeugen • Die Säule besteht aus 5 Profilrohre aus Stahl von Robotern geschweisst: Sehr niedrige Arme, und zwar die ganze Länge entlang paralleles Profil zum Boden. Aufnahmen mit Stecksystem und 90mm Unterschwenkhöhe • Die Übertragung zwischen den Säulen erfolgt mittels einer Welle und Winkelgetrieben mit Kegelräderpaar in Ölbad, die Automatische Dauerschmierung der Schraube • Funktionsweise: elektromechanisch



Installation possible même sur les sols qui ne garantissent pas un bon ancrage • Colonne composée de 5 tubes d'acier soudés par robot • Bras courts en trois parties pour faciliter le chargement de véhicules larges ou tout-terrain • Bras extra plats, avec profil parallèle au sol sur toute la longueur: tampons à rallonge d'une hauteur minimum de 90 mm seulement Particulièrement indiqués pour le levage de véhicules sportifs ou à châssis surbaissé • Moteur spécial à haute performance pour garantir puissance et durée dans le temps, équipé de sonde thermique de sécurité • Fonctionnement: électro-mécanique



Instalación posible sobre suelos que no garantizan un anclaje seguro • Columna compuesta por 5 tubulares de acero, soldados con robots • Brazos cortos de tres extensiones para el levantamiento de vehiculos anchos y todo terrenos • Brazos extra bajos, con perfil paralelo al suelo a lo largo del brazo entero: tacos de extensión con altura minima del suelo de sólo 90 mm. Recomendado para coches bajos, deportivos, tunings • Lubricación permanente y automática del tornillo • Motor especial de alto rendimiento para garantizar potencia y duración en el tiempo, suministrado con termico de protección • Funcionamiento: electro-mecánico



254 BF

3,6 t

CE

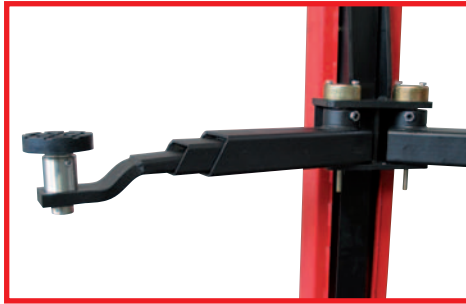

Arresto bracci a inserimento automatico e sgancio automatico a terra

Automatic locking & unlocking of arms during on floor

Schwenkarmarretierung rastet automatisch ein (in der unteren Nullstellung) und auss (beim Heben aus der Nullstellung)

Arrêt des bras à insertion automatique et désinsertion automatique à terre

Parada de brazos de activación automática y desenganche automático de tierra



Comando a uomo presente, 24V

Dead man controls, 24V

24V - Totman-Schaltung

Commande "homme mort", 24V

Mandos de hombre presente, 24V

Bracci predisposti per l'alloggiamento rapido di prolunghe

Arms suitable for quick drop-in extensions

Aufnahmen mit Schnellstecksystem erleichtern den Einsatz von Verlängerungen.

Bras prévus pour le montage rapide de rallonges

Brazos predisuestos para el alojamiento rápido de suplementos.

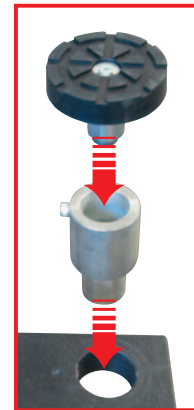

Due motori speciali autofrenanti ad alto rendimento per garantire potenza e durata nel tempo, dotati di sonda termica di protezione

Two specially manufactured self-braking high performing motors to provide long life; fitted with protecting thermic sensor

Zwei spezielle selbstbremsende Hochleistungsmotore mit Thermoschutz liefern üppig bemessene Antriebsleistung und gewährleisten lange Lebensdauer

Deux moteurs spéciaux autofreinants à haute performance garantissent puissance et durée dans le temps; équipés de sonde thermique de protection

Dos motores especiales autofrenantes de alto rendimiento para garantizar potencia y duración en el tiempo; suministrado con térmico de protección



Opzioni



Optionals



Sonderzubehör



Options



Opcionales

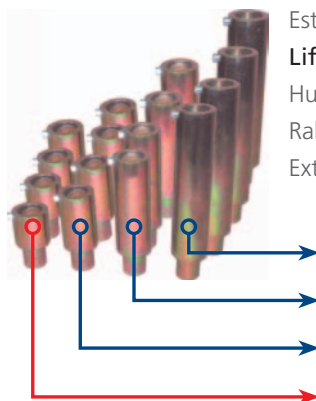

Estensioni per tamponi (kit 4 pz)

Lifting pad extensions (4 pcs set)

Hubspindelverlängerungen (Satz 4 Stk)

Rallonges pour tampons (jeu de 4 pcs)

Extensiones para tacos (kit 4 un.)

250 mm (L955)

170 mm (L954)



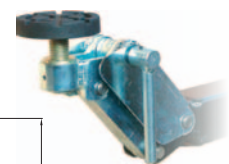
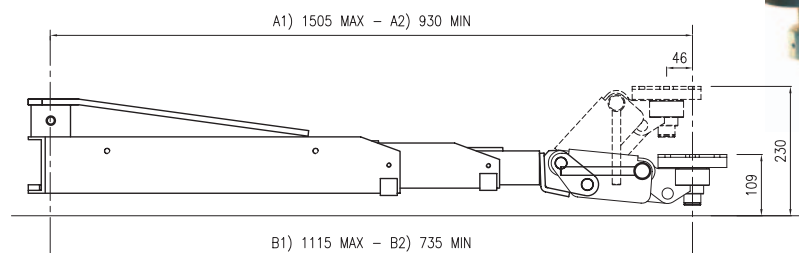
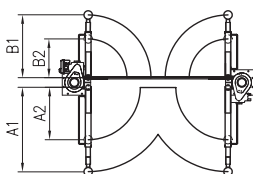

100 mm (L953)

60 mm (L956 standard included)

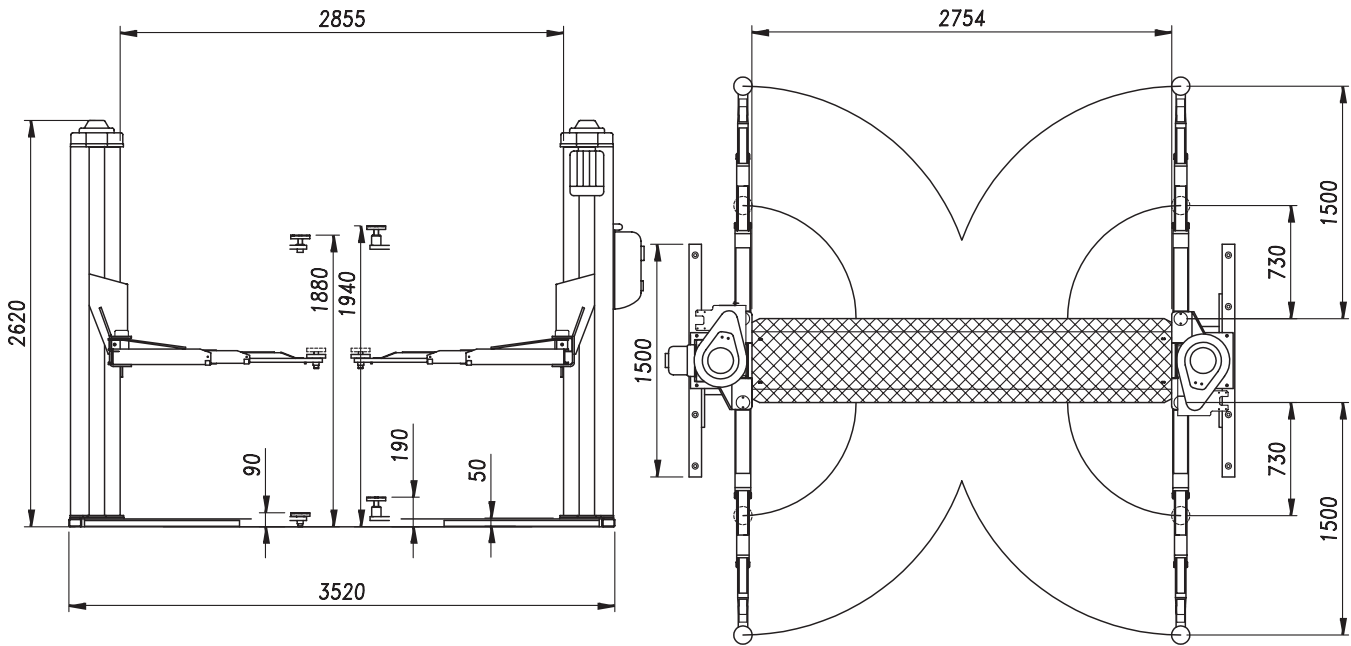
Tamponi click system • Click system pads • Tragteller mit Click System • Tampons de levage click system • Tacos click system





 Dati tecnici	 Technical data	 Technische Eigenschaften	 Caractéristiques techniques	 Datos técnicos	
Portata	Capacity	Tragfähigkeit	Capacité	Capacidad	3.600 kg
Peso	Weight	Gewicht	Poids	Peso	900 kg
Salita/Discesa	Lifting/lowering	Hub/Senkzeit	Levage/descente	Subida/Bajada	55 s
Altezza di sollevamento	Lifting height	Hubhöhe	Hauteur de levage	Altura de elevación	1880 mm
Motore	Motor	Motorleistung	Puissance moteur	Motor	2 x 2,6 kW - 3 ph 230-400V/50 Hz

The company reserves the right to introduce improvements in design or specification without prior notice