







Butler

NAV
26HW.T

Navigator 26HW.T

HIGHWAY

-  **SMONTAGOMME PER SERVIZIO MOBILE**
-  **TYRE CHANGER FOR ROAD-SIDE SERVICE**
-  **MONTIERMASCHINE FÜR MOBILEN EINSATZ**
-  **DÉMONTÉ-PNEUS POUR SERVICE MOBILE**
-  **DESMONTADORA PARA SERVICIO MÓVIL**



Hydraulic Tilting

Smontagomme autocarro retrattile, adatto sia a furgoni chiusi che a furgoni telonati. Ideale per assistenza pneumatici su strada, può operare sia su pneumatici autocarro che agricoli. Azionamenti elettroidraulici. Mandrino idraulico.

Retractable truck tyre changer suitable for closed vans. Ideal for road-side tyre service, it is suitable for both truck and also for agricultural tyres. Electro-hydraulic movements. Hydraulic chucking table.

Einfahrbares LKW-Montiergerät, geeignet für Lieferwagen und geschlossene Anhänger. Ideal für den Serviceinsatz auf der Strasse, es kann sowohl LKW- als auch Landwirtschaftsräder montieren. Die Steuerung ist elektrohydraulisch. Hydraulische Spannvorrichtung.

Démonté-pneus PL rétractile, apte soit aux fourgons fermé qui aux fourgons bâchés. Idéal pour assistance pneus sur rue, il peut opérer soit sur pneumatiques PL que agricoles. Actionnements électro-hydrauliques. Mandrin hydraulique.

Desmontadora para camiones retráctil, ideal para furgonetas cerradas o furgonetas con toldo carrozadas. Perfecta para asistencia de neumáticos en carretera, puede operar tanto con neumáticos para camiones cuanto con neumáticos agrícolas. Movimientos electrohidráulicos. Plato mandril hidráulico.

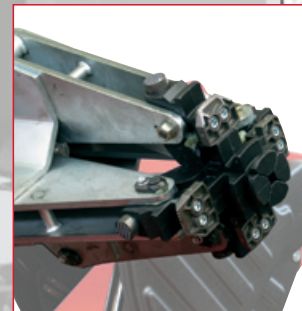

Hydraulic Wheel Minimum Clamping

Ø 90 mm (3,5")

Stand-by function

Dopo 5 secondi di inutilizzo il motore si spegne.
After 5 sec. of no use, the motor turns off.

Bei nicht Benutzung geht nach 5 Sek. das Aggregat in Standby.

Après 5 secondes sans utilisation le moteur s'éteint.
Después de 5 segundos de no utilizzo el motor se apaga.



QUICK Demounting



QUICK Mounting



Easy Setting



VARGNAV26TBT



Variante per comandi Bluetooth
Version with Bluetooth controls

Easy Clamping



Compact + Light



NAV 26HW.T

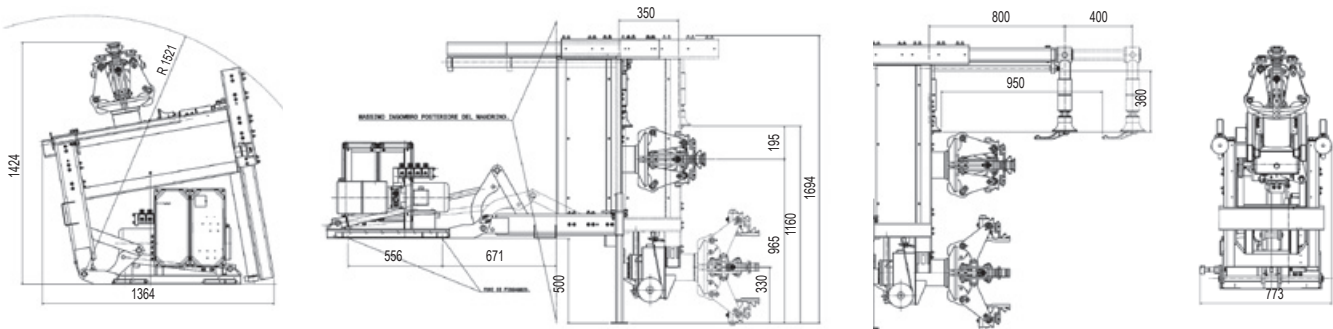

DATI TECNICI	TECHNICAL DATA	TECHNISCHE DATEN	DONNEES TECHNIQUES	DATOS TÉCNICOS	NAV26HW.T
Motore rotazione mandrino	Chucking unit rotation motor	Motor für Drehung der Spannvorrichtung	Moteur rotation mandrin	Motor rotación plato	kW 1,5
Motore centralina	Hydraulic drive unit motor	Hydraulikmotor	Moteur de la pompe	Motor unidad hidráulica	kW 2,2
Ø cerchi	Rim Ø	Felgen-Ø	Ø de la jante	Ø de llantas en pulgadas	11"-27"
Ø est. ruota ammesso	Max. wheel Ø	Raddurchmesser	Ø de la roue	Ø maximo ext. rueda	1300 mm (51")
Larghezza max. ruota	Max. allowed wheel width	Max. Radbreite	Largeur maxi de la roue	Ancho max. rueda	950 mm (37.4")
Peso	Weight	Gewicht	Poids	Peso	403 kg/888 lb
Potenza stallonatore	Bead breaker power	Abdrückkraft	Force du détalonneur	Force du détalonneur	N 16000
Peso max ruota	Max wheel weight	Maximales Radgewicht	Poids maxi de la roue	Poids maxi de la roue	1200 kg/2645 lbs
Velocità di rotazione mandrino (gir/min)	Chuck rotation speed (rev/min)	Sperrvorrichtungs-Drehgeschwindigkeit (U./min.)	Vitesse de rotation du mandrin (tours/min.)	Velocidad de rotación mandril (rev./min.)	8
Coppia max al mandrino	Max. torque to chuck	Max. Sperrvorrichtungs-Drehmoment	Couple max. au mandrin	Par máx al mandril	2200 Nm (1620 FtLbs)



G90A6
Morsa per cerchi in lega
Alu rim clamp

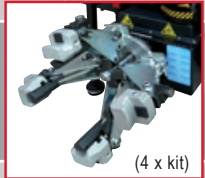

G108A1 fino al/before 2/2013
G108A2 da/after 3/2013
Protezioni per cerchi in lega
Alu protection

OPTIONS

Butler

Engineering & Marketing S.p.A. a.s.u.
Via dell'Ecologia 6 - 42047 Rolo (RE)
Ph. +39-0522-647911 - Fax +39-0522-649760
www.butler.it - info@butler.it

Le caratteristiche tecniche e gli allestimenti presentati in questo prospetto possono subire variazioni. Le immagini riprodotte non sono vincolanti.
Technical data and composition presented in this catalogue may vary. Pictures reproduced are only indicative.
Die techn. Daten und die Ausrüstungen, die in diesem Prospekt enthalten sind, können Änderungen erfahren. Deshalb sind die Abbildungen unverbindlich.
Les caractéristiques techniques et les compositions présentées dans ce prospectus peuvent subir des variations. Les images reproduites n'ont qu'une valeur indicative.
Las características técnicas y las composiciones ilustradas en este folleto pueden sufrir variaciones. Las imágenes propuestas son solamente indicativas.